

ONSITE SEWER & WATER EXHIBIT

GENERATIONS AT GREEN VALLEY













RECEIVED
 NOV 30 2022
 EL DORADO COUNTY
 PLANNING AND BUILDING DEPARTMENT

COUNTY OF EL DORADO

NOVEMBER, 2022

STATE OF CALIFORNIA

LEGEND

-  SUBDIVISION BOUNDARY
-  PROPOSED WATER LINE
-  PROPOSED GRAVITY SEWER LINE
-  PROPOSED SEWER FORCE MAIN
-  PROPOSED INDIVIDUAL SEWER PUMP
-  PROPOSED SEPTIC SYSTEM
-  POTENTIAL DISPOSAL AREA
-  EXISTING GRAVITY SEWER LINE
-  EXISTING WATER LINE
-  JURISDICTIONAL WATERS
SEE REPORT PREPARED BY
MADRONE ECOLOGICAL CONSULTING
FOR ADDITIONAL INFORMATION
-  EXISTING SLOPES ≥ 30%
-  EXISTING WELL (APPROX LOCATION
BASED ON AVAILABLE INFORMATION)

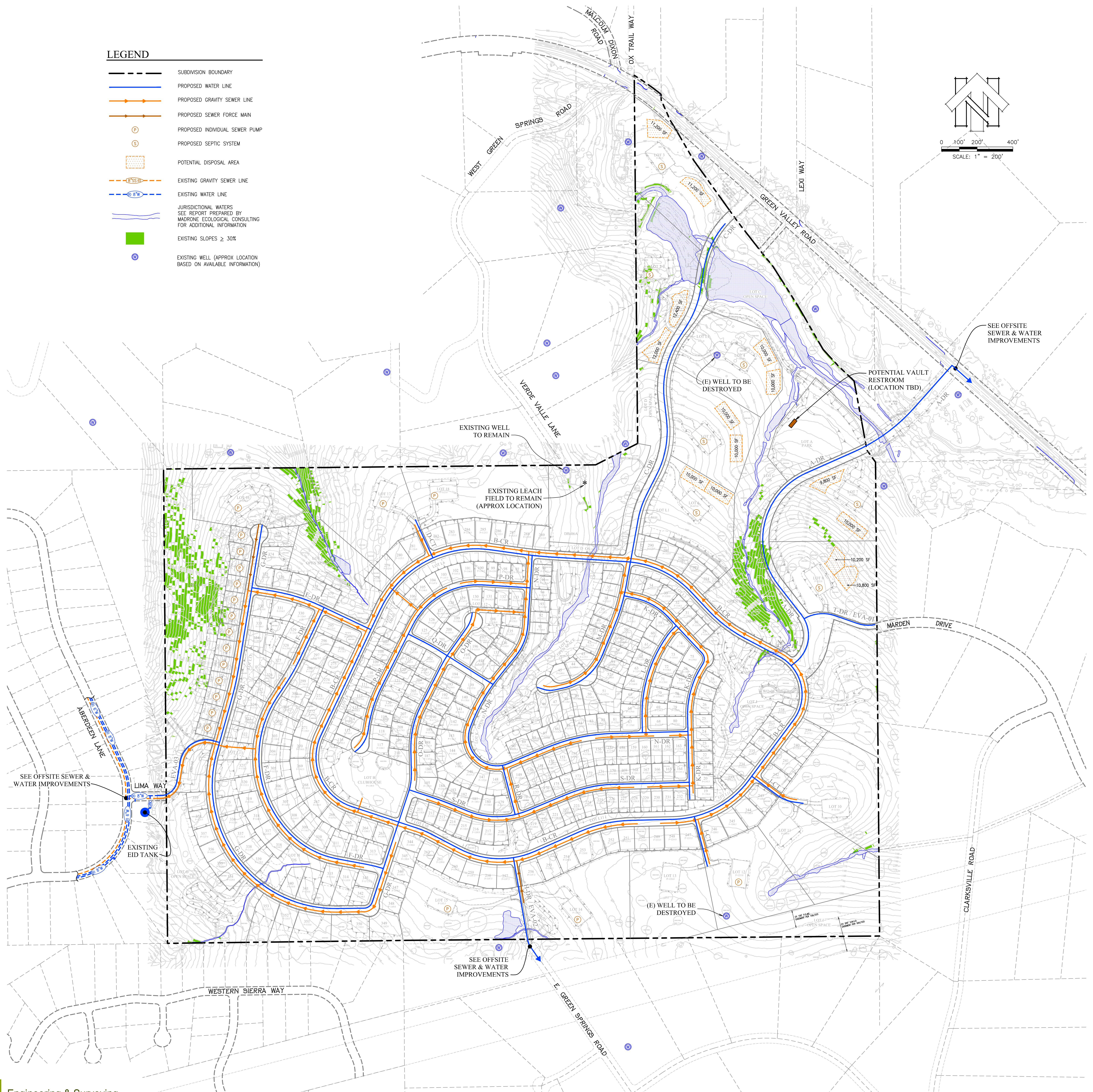
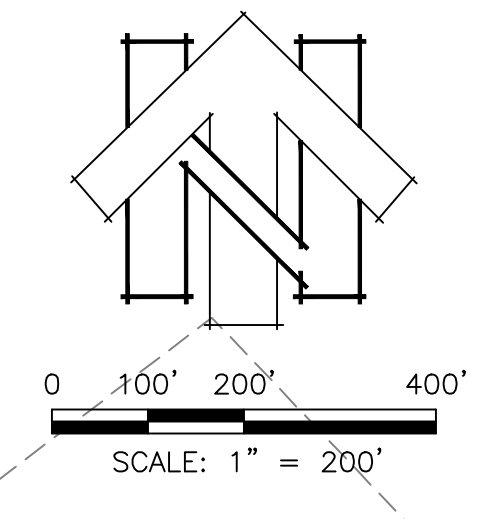

SEE OFFSITE SEWER & WATER IMPROVEMENTS

POTENTIAL VAULT RESTROOM (LOCATION TBD)

EXISTING WELL TO REMAIN

EXISTING LEACH FIELD TO REMAIN (APPROX LOCATION)

SEE OFFSITE SEWER & WATER IMPROVEMENTS

EXISTING EID TANK

SEE OFFSITE SEWER & WATER IMPROVEMENTS

(E) WELL TO BE DESTROYED